



**Reverse osmosis equipment for dish/glass washmachines**  
**7280.0145**

User Manual  
Gebruikershandleiding  
Gebrauchsanweisung  
Le mode d'emploi



# INDEX

<b>1</b>	<b>GENERAL INFORMATIONS</b> .....	<b>3</b>
1.1	MANUFACTURER / ASSISTANCE .....	3
1.2	CERTIFICATION .....	3
1.3	AIM AND CONTENTS .....	3
1.4	CONSERVATION .....	3
1.5	SYMBOLS USED .....	3
<b>2</b>	<b>EQUIPMENT FEATURES</b> .....	<b>4</b>
2.1	USE .....	4
2.2	PARTS THAT MAKE UP THE MACHINE .....	4
2.3	COMPONENTS .....	5
2.4	DESCRIPTION .....	5
2.5	TECHNICAL SPECIFICATIONS .....	7
<b>3</b>	<b>INSTALLATION</b> .....	<b>8</b>
3.1	INSTALLING THE DRAIN CLAMP .....	9
<b>4</b>	<b>FUNCTIONING</b> .....	<b>9</b>
4.1	FIRST START UP .....	9
4.2	NORMAL USE .....	10
4.3	INACTIVITY .....	10
4.4	ELECTRONIC BOARD OPERATING .....	10
<b>5</b>	<b>ROUTINE MAINTENANCE</b> .....	<b>13</b>
5.1	MAINTENANCE PERSONNEL QUALIFICATIONS .....	13
5.2	MAINTENANCE PERSONNEL TASKS .....	13
5.3	REPLACING FILTER CARTRIDGE .....	14
5.4	PRELOAD EXPANSION TANK .....	14
5.5	VERIFICATION OF THE SETTING .....	15
5.6	CLEANING CONDUCTIVITY PROBE CONNECTORS .....	15
5.7	CLEANING SOLENOID VALVES FILTER .....	16
5.8	MACHINE SANITATION .....	16
<b>6</b>	<b>EXTRAORDINARY MAINTENANCE</b> .....	<b>17</b>
6.1	ELECTRONIC BOARD WHIT DISPLAY REPLACEMENT .....	17
6.2	PROTECTION FUSE REPLACEMENT .....	17
6.3	PUMP REPLACEMENT .....	18
6.4	CHECK/REPLACEMENT OF OSMOTIC MEMBRANES .....	19
<b>7</b>	<b>TROUBLE-SHOOTING</b> .....	<b>20</b>
	<b>ATTACHMENT I – CE DECLARATION</b> .....	<b>23</b>
	<b>ATTACHMENT II – SPARE PARTS AND ACCESSORIES LIST 7280.0145</b> .....	<b>24</b>
	<b>ATTACHMENT II – CE LABEL</b> .....	<b>24</b>
	<b>ATTACHMENT IV – MAINTENANCE LOG</b> .....	<b>25</b>
	<b>ATTACHMENT V - ELECTRONIC BOARD CONNECTION</b> .....	<b>26</b>

# 1 GENERAL INFORMATIONS

## 1.1 MANUFACTURER / ASSISTANCE

MANUFACTURER	ASSISTANCE
Aristarco S.p.A. Via del Lavoro, 30 31033 Castelfranco Veneto (TV) - Italy	Personal Data of the Retail Seller

## 1.2 CERTIFICATION

7280.0145 was manufactured in compliance with the following EU Directives:

Machines	2006 / 42 / CE
Low Voltage	2006 / 95 / CE
Electromagnetic Compliance	2004 / 108 / CE

## 1.3 AIM AND CONTENTS

The purpose of this manual is to provide the user with all the necessary information so that, apart from correct machine use, he or she is able to run it in the most autonomous and safest way. It also includes information on operating the machine and routine maintenance.

### ATTENTION



This manual is for both users and technicians in charge of machine maintenance. Before carrying out any operation on the machine, both the users and installation personnel as well as qualified technicians must carefully read the instructions in this manual.

Users can only carry out the operations indicated in this manual and must not perform any operations reserved for maintenance personnel or qualified technicians.

### ATTENTION



All maintenance operations must be performed by qualified personnel.

## 1.4 CONSERVATION

The instruction manual is an integral part of the machine, therefore it must be kept within reach, inside a proper container and, above all, safe from liquids and any other substance that could make it illegible.

## 1.5 SYMBOLS USED

### GENERAL DIRECTIONS



Indicates a warning or notes on key functions or useful information. Pay the utmost attention to texts indicated by this symbol.



Indicates a manual adjustment that can also foresee the use of portable equipment or utensils.



Requires finding a measurement value, checking a signal, carrying out a visual control, etc.

### DANGER INDICATIONS



Generic danger, with risk to the user



Danger of lectrical kind.

### PROHIBITION INDICATIONS



Prohibited.

## 2 EQUIPMENT FEATURES

### 2.1 USE

7280.0145 is an equipment designed for dish/glass wash machine water treatment. It is able to modify organoleptic and chemical characteristics of potable water, reducing saline content.

The machine can preserve water from possible problems that can occur below the aqueducts, such as infiltrations due to work on the network or breakage, and also from the consequences of keeping water in decantation basins.

7280.0145 is used to supply treated water to dishwasher and glasswasher machines, with frontal load. The internal pressure tank can supply up to 5lt of treated water with an instant maximum capacity of 15lt/min, at a pressure of 2.5bar.

The treated water capacity is 1.5lt/min; water is stored in the pressure tank to supply high quantity of water during the rinsing phase of the dish/glass washmachine cycle.

#### ATTENTION



The water consumption of the dish/glass washmachine installed after the 7280.0145 must respect the maximum performance of the system.



All components of the dish/glass washmachine in contact with water must be compatible with osmosi treated water.



It is forbidden to use brass; all tanks and pipes in stell AISI 304 must be without weldings.



It is racommended to use only plastic parts and stell AISI 316.



The company Combisteel BV is not responsible of any damage or injury to things or people if these instructions are not respected.

#### ATTENTION



7280.0145 is not a water purifier.

Using 7280.0145 to condition water that is not drinkable is ABSOLUTELY PROHIBITED.

### 2.2 PARTS THAT MAKE UP THE MACHINE

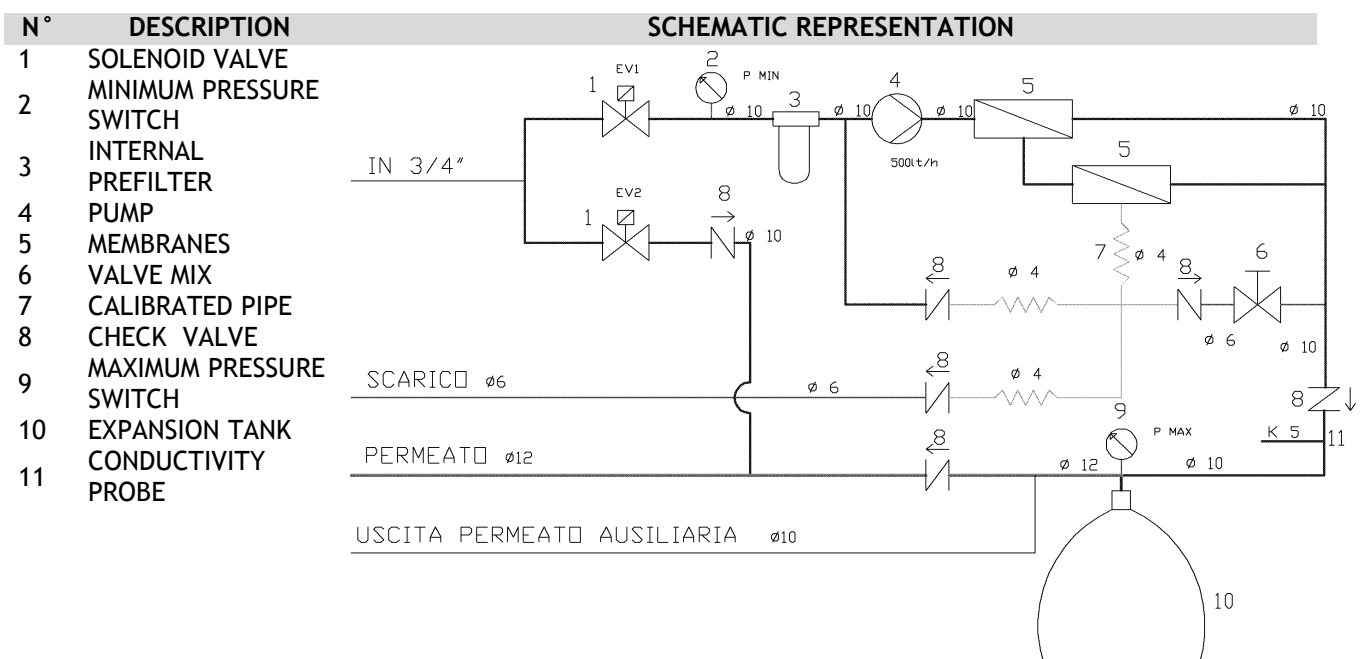

## 2.3 COMPONENTS

### 2.3.1 Internal prefilters

The device is equipped with a PROFINE S BLU carbon block.

### 2.3.2 Membrane

The membranes are the core of the machine; two membranes TW3012 300gpd are installed.

### 2.3.3 Pressure Tank

The machine has inside a 24lt pressure Tank with replacable membrane to store treated water.

## 2.4 DESCRIPTION

The machine has on the rear side no.4 hydraulic connections, for inlet water, permeated water, drain and auxiliary permeate outlet.

On the rear side, there is also the electric socket whit fuse.

On the front side of the machine, there is the electronic board with display, the ¼ turn rapid filter and the mix valve.

N°	DESCRIPTION	GENERAL SCHEMATIC REPRESENTATION	
1	POWER SOCKET		
2	PERMEATED OUTLET		
3	SOLENOID VALVE WATER INLET		
4	AUXILIARY OUTLET		
5	DRAIN		
6	FILTER		
7	ELECTRONIC BOARD		
8	MIX VALVE		

From the inlet valve, the water flows to the inlet solenoid valve, on the rear side of the machine, and then through the prefilter.

After prefiltering, the water is pumped at high pressure to the osmosis vessel with membranes.

The sediment filtration removes suspended solids from water that may damage pump and membranes. The activated carbon filters facilitate the elimination of the unpleasant chlorine taste, without compromising the desirable mineral properties of the water. These activated carbon filters can also absorb potential trace organic micro pollutants, various chemicals organic and inorganic (i.e. chlorine composites), chlorine residue used to disinfect water, haloforms, pesticides, surface-active agents.

The reverse osmosis phase is the last and most important process that occurs inside the membrane itself. The water permeates the layer flowing into the collection tubes, and then it is directed to the main tube of the membrane, wrapped in various layers. The permeate yield comes from the main tube of the membrane and is sent directly to the permeate outlet.

While the membrane allows the water to filter through, it traps the unwanted concentrated impurities.

The drainage flow is also used to clean the membrane and is directly connected to the drainage system by plastic brackets.

The mix valve allows the user to choose the hardness or the saltiness of the water produced. The mixer should be calibrated during the installation phase.

7280.0145 permits the treated water to retain about 10 to 15% of the original saline properties.

The machine has a conductivity probe to check water quality on the display.

For the start/stop signal, the machine has a high pressure switch on the permeate line.

For pump safety, the machine has an adjustable minimum pressure switch.

The machine has an auxiliary bypass solenoid valve to supply raw water if water consumption is higher than the maximum performance of the machine.

#### ATTENTION



The percentage of dissolved salts and other rejected elements is influenced by the water quality, temperature, pressure, and total dissolved salts and differs according to the type of salts or elements.



The treatment of particularly turbid water or water with many impurities can clog the prefilters and/or membranes, causing a loss in water flow rate.



Reflux water, salt water or water in chemical, physical and bacteriological conditions that cannot be treated by Reverse Osmosis (industrial reflux or chemical processing) cannot be treated.

## 2.5 TECHNICAL SPECIFICATIONS

<b>7280.0145 STANDARD</b>	
<b>TECHNICAL SPECIFICATIONS 7280.0145</b>	
Height x Width x Depth (mm)	300x462x688
Weight (kg)	30
Approved Decibel Level under normal operating conditions (dB (A))	<70
R/O Membrane (n° 2)	3012 300GPD
Filter with active carbon	Carbon block quick connection
<b>WATER SUPPLY SPECIFICATIONS</b>	
Water type	Drinkable
Minimum temperature (° C)	5
Maximum temperature (° C)	30
Minimum inlet capacity (l/h)	400
Maximum inlet pressure (bar)	3
Minimum inlet pressure (bar)	1,5
<b>POWER SUPPLY SPECIFICATIONS</b>	
Power supply type	MONOPHASE + GROUND
Voltage (V)	230
Frequency (Hz)	50
Absorbed current (A)	2.5A
Power (W)	250W
Fuse type electronic board	F5A
Fuse type elettrica connector	F4A
<b>PERMEATE WATER SPECIFICATIONS</b>	
Maximum capacity at 15° C (l/h)	c.a 120
Flow with pressure at 3 bar of 15° C (l/h)	c.a 80
Recovery (%)	c.a 50
<b>OPERATION UNDER NORMAL WORKING CONDITIONS</b>	
Filter with active carbon (l)	22.000
R/O Membrane	UPON CLOGGING

### ATTENTION



Any use of this device, which has not been stipulated in this manual, will constitute IMPROPER USE, thereby rendering the guarantee null and void. The manufacture WILL NOT be liable for any damages caused by the IMPROPER USE of this device, due to negligence, failure to follow the manual, or permitting unauthorized maintenance personnel to tamper with machine.

### 3 INSTALLATION

7280.0145 installation must be performed in a cool, dry and well ventilated place.

#### ATTENTION



7280.0145 must be installed by **qualified personnel and in compliance with regulations**, there must be a tap above (to exclude the equipment from the water system in the case of maintenance interventions), a check valve, water supply pipes above and below the equipment and an electrical outlet.



Avoid subjecting the machine to excessive temperature changes that could cause condensate to form inside, which can damage the electronic part.



Make sure the air vents are never blocked in order to not compromise motor cooling.



Instructions and representation to follow are to be considered for typical installations, the specific components may vary depending on the accessories that accompany the car and taps derivation and delivery chosen.

#### CONTROLS TO BE CARRIED OUT BEFORE INSTALLATION



Mains grounding present and efficient

Main compatible with the electrical specifications indicated on the plate on the back of the machine

Diameter of feed circuit electrical wires greater than 1 mm



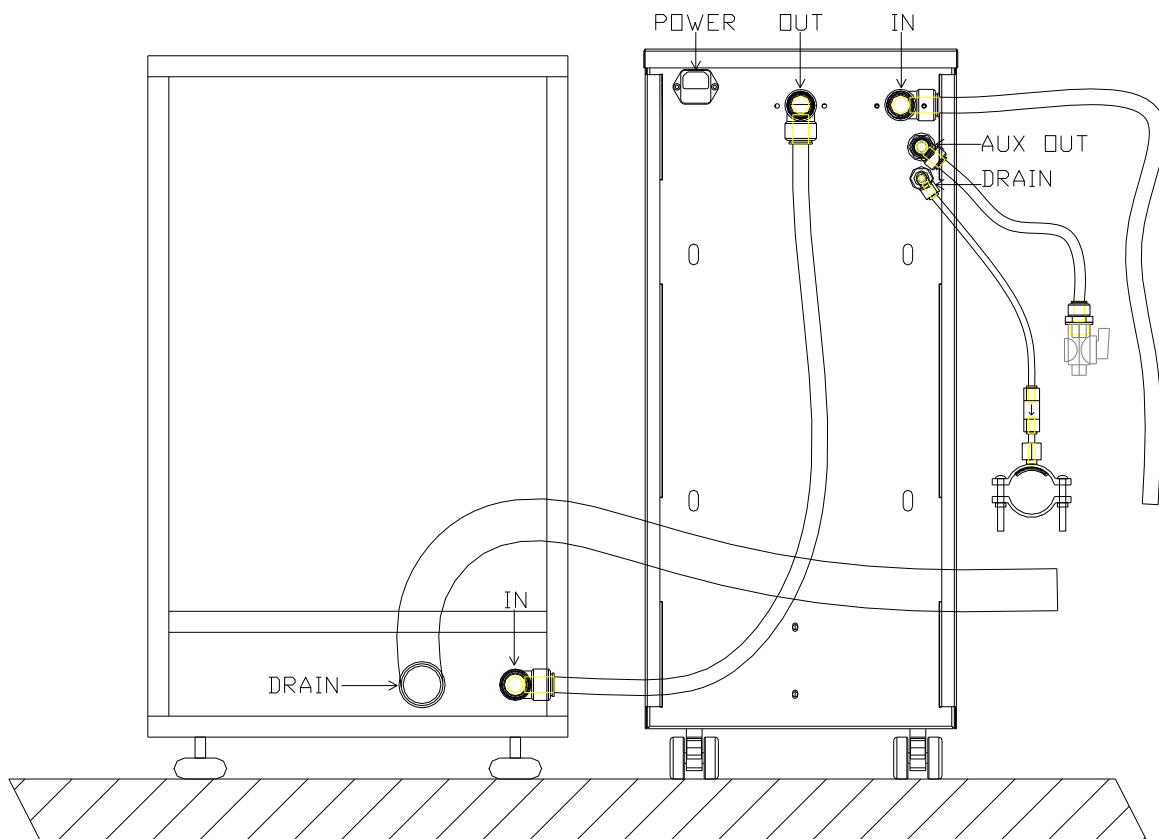

Stability of network tension (rushes lower than 10%)

#### TYPICAL INSTALLATION DIAGRAM





### 3.1 INSTALLING THE DRAIN CLAMP

	Install the drain clamp on the drain siphon diam. 40mm of the sink. Make sure the washer correctly rests on the pipe and the bolts are tightened.
	Remove the screw nut from the drainpipe.
	Using a drill with 4-mm tip, make a hole in the drain siphon pipe in correspondence with the nut that has just been removed.
	Insert the drainpipe in the nut for about 2 cm and screw the nut on the clamp.
	Fasten the screw nut and install the check valve with the arrow pointing towards the clasp, as near as possible to the drain.

1. Drain pipe 6mm
2. Check valve 6mm
3. Drain pipe screw nut
4. Drain clasp
5. Washer
6. Bolt
7. Bolt screw nut
8. Sink drain siphon pipe

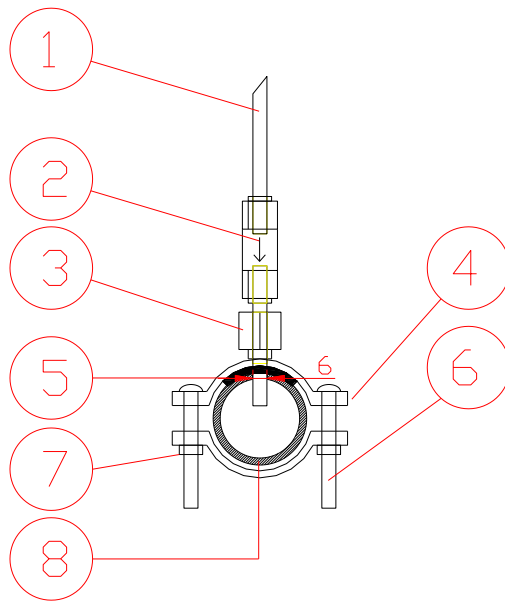

## 4 FUNCTIONING

### 4.1 FIRST START UP

### ATTENTION



The first start up of the system must be carried out by the installer who will make sure the machine runs properly.



Insert the feed plug in a 230V 50Hz outlet equipped with efficient grounding. Now the system is able to work. It is advisable to run the machine for at least a half an hour before drinking it, in order to allow the system to eliminate the substances used to conserve the reverse osmosis membrane.



Make sure there are no leaks in the circuit and fasten the antiflooding probe on the bottom of the machine.



Close the cover with the screws position the machine in its final destination and push the brakes of the wheels.



Operate sanitation of equipment as described in section 5.8.

The 7280.0145 membranes are provided saturated in a maintenance solution. Before taking water, let it run for at least 15-30 minutes.

#### 4.2 NORMAL USE

In order to normally use 7280.0145 the machine must always be kept on.

The machine starts automatically at every rising cycle of the dish/wash machine. Every six hours the machine automatically opens the inlet solenoid valve, in this way the membranes are washed for 2 minutes. To adjust the salinity of the water, acting on the valve for mixing later.

If high water consumption occurs, the by-pass solenoid valve opens and raw water flows to the outlet.

### ATTENTION



Absolutely avoid letting the membranes dry out; this could irreparably compromise its functioning.

#### 4.3 INACTIVITY

### ATTENTION



It is advisable, each time the machine is inactive for a period over one week, to let the water run for at least 10 minutes before using it.



It is advisable to sanitize the system every six months during routine maintenance procedures.

Contact assistance in order to carry out this operation, which must be performed by specialized personnel/installation technicians.

#### 4.4 ELECTRONIC BOARD OPERATING

##### 4.4.1 Normal functioning

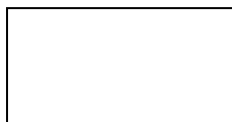

When the card is in normal functioning mode, the name of the reseller is displayed.

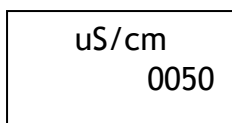

When the faucet is opened, the machine starts to produce permeate water; pushing the key ENTER , the conductivity is displayed.

When the faucet will be closed, the board returns in stand-by mode.

##### Main water pressure failure

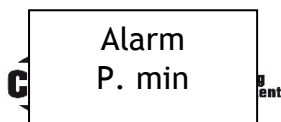

When faucet is opened, if low pressure failure occurs, the display shows “Alarm P. min” and the board makes a beep.

To restart the machine, turn OFF and ON with the key .

#### Leakage

Alarm  
Leakage

If water leakage alarm occurs, the machine stops and makes a continuous beep displaying “Alarm Leakage”.

To restart the machine, turn OFF and ON with the key .



#### 4.4.2 Display pages

When the card is in stand-by mode, the name of the installer is displayed.

Mikrotec  
Ver 1.02



Pressing the  key displays the version of software installed in the card.

Manual  
Flush.

To scroll the next pages press the  key ; the first page displayed enables carrying out the manual flow of the membrane; in order to carry out the operation, press the  key; the card displays “Flow in progress”.



Flushing

T remain  
0000:00

Pressing the  key again moves to the display of the hours-minutes of remaining functioning before the filter change; from this page, pressing the  key displays the residual autonomy.

L remain  
0000000

T Total  
0000:00

Pressing the  key again moves to the display of the hours-minutes of running since the last reset; from this page, pressing the  key displays the total liters consumed.



L Total  
0000000

#### 4.4.3 Programming pages

Settings  
Press E

In order to have access to the programming pages, unplug the machine and press the  key while connecting the feed plug.

Subsequently the card will require pressing the  key to confirm access to the programming.

Scroll the programming pages with the  and  keys.

Data saved

Each time a value is modified, press the  key to confirm the change and save the datum; “Loaded value” appears on the display and it returns to the programming menu.





Filter Reset

The first page enables the hour counter reset by pressing the  key.

Press E to reset





The card displays “press E Reset T”; pressing the  key again confirms the zeroing of the counter; the card will therefore display “Data saved”

Faucet Setting





Move to the next page with the  key; access the selection of the tap type with the  key. Select the type of tap (manual or electric) with the  and  keys and confirm with the  key. The card therefore indicates “Data saved”

Manual Faucet

Customer Setting

Move to the next page with the  key; access the selection of the writing in stand-by with the  key. Select the saved names with the  and  keys and confirm with the  key. The card therefore indicates “Data saved”

Function mode





Move to the next page with the  key; access the selection of the functioning mode with the  key. Select functioning by time or without time limit with the  and  keys and confirm with the  key. The card therefore indicates “Data saved”

Time limit





**In equipment for household use the time limit functioning is recommended.**

K converts setting

Move to the next page with the  key; access the modification of the liters/hour conversion parameter with the  key. Modify the value with the  and  keys and confirm with the  key. The card therefore indicates “Data saved”

K Convs  
lt/h 180





Time setting

Move to the next page with the  key; modify the “filter hours” parameter with the  key. Modify the value with the  and  keys and confirm

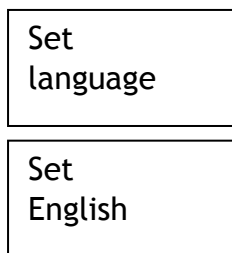
Funz  
h 0070

with the  key. The card therefore indicates “Data saved”



Move to the next page with the key  ; modify the language parameter with the key  . Set the language with the keys  and  and confirm with the key  . The card therefore indicateds “Data saved”.

## 5 ROUTINE MAINTENANCE

### 5.1 MAINTENANCE PERSONNEL QUALIFICATIONS

Personnel in charge of Maintenance must have the requisites indicated in the following and be familiar with this manual and all information concerning safety:

- Sufficient level of general and technical knowledge in order to understand the contents of this manual.
- Knowledge of the main hygienic, accident-prevention and technological regulations.
- Complete knowledge of the machine as well as electrical and hydraulic problems that can arise where the machine is installed.

### 5.2 MAINTENANCE PERSONNEL TASKS

The routine maintenance program described in this paragraph must be carried out according to the schedule indicated in order to keep the machine running efficiently and to guarantee the quality of the water treatment.

#### ATTENTION



The operations indicated in the following must be carried out by qualified personnel according to the instructions in this manual and only using original spare parts. Maintenance performed must be documented and signed by the technician in charge in the proper space on the maintenance register in the ATTACHMENT. It is advisable to carry out routine maintenance at least once every 6 months, even if the filters have not run out.

ITEM TO CHECK	CONTROL	FREQUENCY
Machine	Preload expansion tank	6 MONTHS
	Visual control of the integrity and state of conservation	o
	General cleaning	10000 liters (*)
	Check running	
Filters with active carbon	Replacement	22.000 liters

(\*)Particular water conditions can require more frequent maintenance.

#### ATTENTION



Use only original parts.

#### ATTENTION



The internal 7280.0145 electrical apparatus is fed by 230-VOLT electrical current. Before opening the machine, remove covers and/or panels and/or protection grids and make sure the switch is off and the machine is unplugged.

#### ATTENTION



When cleaning the machine do not use corrosive products, acids, abrasive or steel brushes.  
Do not directly wash the machine with high-pressure jets of water.

### 5.3 REPLACING FILTER CARTRIDGE

To replace the prefilter follow these steps:



Remove the power plug.

Remove the filter cartridge, turning it left  $\frac{1}{4}$ .

Install new cartridge in the machine; take care about the filter o-rings.

Reset the electronic board (if used with time limit function) (see § 4.4.3).

Sterilize the system (see § 5.8).

### 5.4 PRELOAD EXPANSION TANK

To check the preload of the pressure tank, follow these steps:



Remove the power plug.

Empty the expansion tank delivering water to the permeate auxiliary outlet.

Remove the side panels and identify the connection of the preload in the tank.

With a compressor and a pneumatic gun, bring the preload pressure at 2.5bar

Install the panels and connect the power plug.

## 5.5 VERIFICATION OF THE SETTING

For proper operation of the machine, check periodically the calibrations.



All the calibrations must be performed by qualified personnel.

### 5.5.1 Setting pressure switch



Install a pressure gauge (0-6 bar or similar) between the permeate outlet and the faucet.



Screw two turns the calibration nut of the pressure switch.



Open the knob of the tap, after which it slowly close the tap until the pressure gauge reaches about 3.5 bar.



Slowly unscrew the calibration nut of pressure switch until the operation of the machine becomes discontinuous.



Apply the glue sealant to calibration nut.

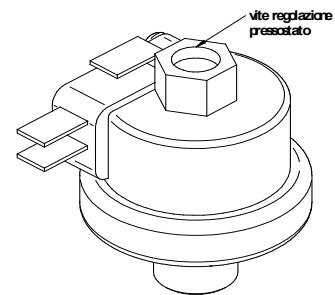

### 5.5.2 Check operating pressure



Install a T fitting and a pressure gauge 0-10 bar (or similar) on the pump outlet line.



The operating pressure must be between 6 and 7 bar.

### 5.5.3 Calibrating conductivity probe



Open the electronic board box.



Start the machine and deliver water.



After 2 minutes, take a sample and measuring the conductivity with a reference instrument properly calibrated.



Turn the conductivity calibration potentiometer until the displayed value matches the value measured by the instrument.



## 5.6 CLEANING CONDUCTIVITY PROBE CONNECTORS



Disconnect the connectors of the conductivity probe.



Clean the male and female connectors from possible oxidation.



Tighten the connector with pliers and reassembly.





## 5.7 CLEANING SOLENOID VALVES FILTER



- Close the inlet water valve.
- Open the faucet to remove the pressure in the feed pipe.
- Turn off the machine and remove the 3/4" fitting from the solenoid valve.
- Using pliers, gently pull the solenoid valve filter.
- Clean the filter with tap water and/or compressed air.

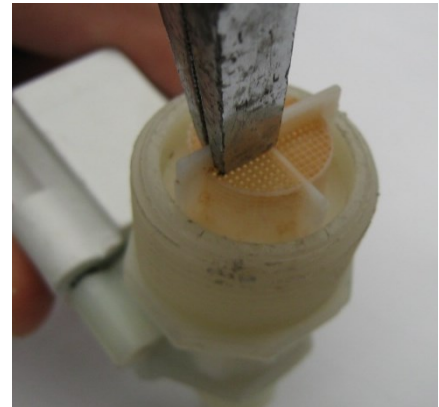

## 5.8 MACHINE SANITATION



Perform the sanitation of the machine at each filter replacement, and at intervals not exceeding 6 months.  
Perform sanitation also after long not-use periods of the machine.



All sanitation operations must be performed by qualified personnel.



Be careful in the use and dosage of chemicals.



Use protective clothing to the skin, hands and eyes as shown in the safety data sheet of chemicals used.



Close the mixing valve and fill a tank with 10 liters of permeate water.



Add hydrogen peroxide to achieve a concentration of 0.2% by weight.  
Put 650ml of hydrogen peroxide at 10 volumes per 10 liters of permeated water.  
Put 250ml of hydrogen peroxide at 24 volumes per 10 liters of permeated water.  
Put 180ml of hydrogen peroxide at 36 volumes per 10 liters of permeated water.  
Put 50ml of hydrogen peroxide at 130 volumes per 10 liters of permeated water.



Connect the water pipes of entry, drain and permeated by the machine, at the tank; make a bridge on the low pressure switch connectors.

Open a bit the mix valve and turn on the machine and let the solution recirculated for at least 10 minutes.

Wait 10 minutes that the solution acts on the machine.

Reconnect the drain and permeated pipes.

Connect the water pipes of entry, drain and permeated by the machine, at the tank.

Turn on the machine until the sanitation solution is empty; then turn off the machine.

Reconnect the inlet water pipe and open the water valve.

Replace the filter and reconnect the cables of the minimum pressure switch.

Turn on the machine and supply water for at least 10 minutes until the sanitification solution residues are totally drained.



## 6 EXTRAORDINARY MAINTENANCE

### ATTENTION



The internal 7280.0145 electrical apparatus is fed by 230-VOLT electrical current. Before opening the machine, remove covers and/or panels and/or protection grids and make sure the switch is off and the machine is unplugged.

### 6.1 ELECTRONIC BOARD WHIT DISPLAY REPLACEMENT



Remove the cover of the machine, accessing the tray card.

Unscrew the screws fastening the electronic board box.

Remove the electronic board box, disconnect the power connector.

Mount the new electronic board with reverse procedure.

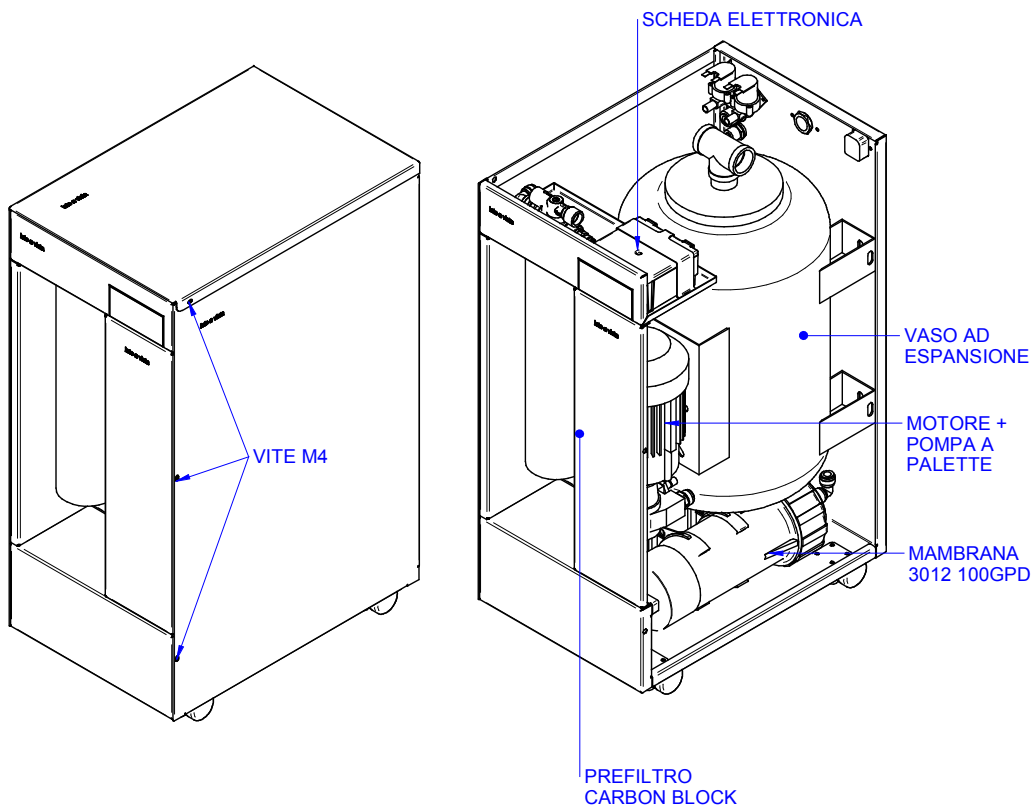

### 6.2 PROTECTION FUSE REPLACEMENT

The machine is equipped with two fuses, one on the electronic board and one on the power socket.

#### 6.2.1 Protection fuse replacement on power socket



Remove the fuse compartment under the attack of the power cord.

Replace the burned fuse with a similar. (Attachment V)

Mount the power cord with reverse procedure.

### 6.2.2 Protection fuse replacement on electronic board



Remove the top cover of the machine, accessing the tray card.

Remove the support and the cover of the electronic board.

Replace the burned fuse with a similar. (Annex V)

Mount the electronic board with reverse procedure.

### 6.3 PUMP REPLACEMENT



Remove the top and right panels of the machine.

Disconnect the piping from the pump.

Unscrew the screw of the clamp connecting and disassemble the pump.

Install the new pump with fittings previously removed.

Mount the new pump with reverse procedure.

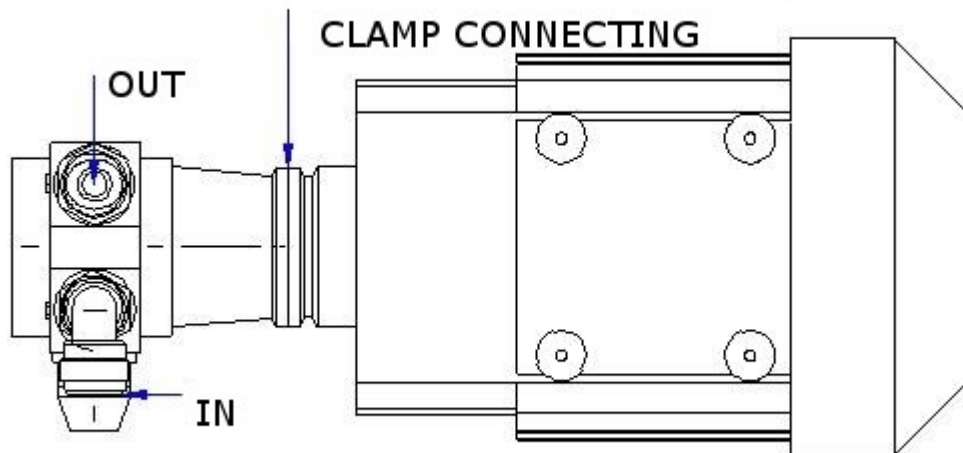

## 6.4 CHECK/REPLACEMENT OF OSMOTIC MEMBRANES



A decay of performance rating of 10% per year is considered normal wear for osmotic membranes. Special conditions of entry and/or high consumption may accelerate the clogging of the membranes.



Close the mixing valve completely.



Supply water and verify scope permeated and conductivity with a reference tool.



If the capacity is reduced more than 50% of the initial conditions and/or the conductivity is greater than 80  $\mu\text{S}/\text{cm}$ , replace the osmotic membrane as follows.



Disconnect the tubes from the fittings of the vessel containing the membrane.



Dismantle the vessel from the machine and unscrew the caps.



Dismantle the membranes clogged and replace with new membranes of the same type.



Clean the vessel on the inside by removing all traces of dirt and scale.



The new membrane must be removed immediately prior to their installation and handling, using protective gloves sterile.



Before installing the membrane in the vessel, lubricate the o-ring and the upper seal.



Install the vessel with reverse procedure.



Supply water for at least 15 minutes, then check permeated flow and quality.

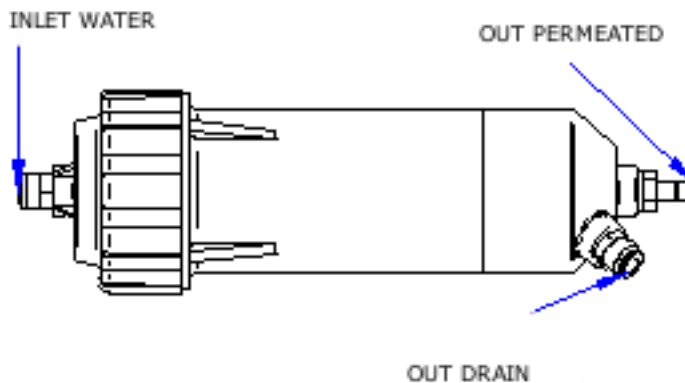

## 7 TROUBLE-SHOOTING



The operations indicated should be performed only by qualified personnel, except those marked with \*.

<b>Problem:</b>	The display is off.	
	<b>Cause</b>	<b>Solution</b>
	Electric supply failure.	Check power plug is connected. *
	Burned fuse.	Open the board cover and check the fuse; if burned replace it.
	Display cable removed.	Check display cable is connected on the board socket.
	Damaged display.	Replace the display.
	Damaged board.	Replace the board.

<b>Problem:</b>	Burned fuse and thermal protection switch.	
	<b>Cause</b>	<b>Solution</b>
	Motor in short circuit.	Replace the motor and the protection fuse of the electronic board.
	Incorrect wiring.	Check the wiring and the fastening of the cables to the terminals.
	Leakage.	Check the insulation of the wiring and clamp, and check the operation of the electronic board.

<b>Problem:</b>	The ground protection switches.	
	<b>Cause</b>	<b>Solution</b>
	Defective motor.	Replace motor.
	Incorrect wiring.	Check the wiring and the fastening of the cables to the terminals.

<b>Problem:</b>	The display shows "Alarm Leakage".	
	<b>Cause</b>	<b>Solution</b>
	Leakage	Open the machine and check carefully all hydraulic circuit for leakages.
	Leakage probe in short circuit.	Check water leakage probe position; if directly at contact with metal parts of the machine, place in a different position.
	Damaged board.	Replace the board.

<b>Problem:</b>	With the display turned on and running, after opening the faucet, the engine will not start.	
	<b>Cause</b>	<b>Solution</b>
	Vane pump blocked.	Replace the vane pump.
	Burned motor.	Replace the motor.
	Incorrect wiring.	Check the wiring and the fastening of the cables to the terminals.
	Incorrect faucet setting manual / electric.	Access the programming menu of the electronic board and check the faucet setting.

<b>Problem:</b>	With the board on, at operating start, the inlet solenoid valve never opens.	
	<b>Cause</b>	<b>Solution</b>
	Solenoid valve damaged.	Replace the solenoid valve.
	Coil burned.	Replace solenoid valve coil.
	Electric connection failure.	Check electric connections and tight if necessary.

<b>Problem:</b>	Low permeate water production.
<b>Cause</b>	<b>Solution</b>
Clogged solenoid valve.	Check solenoid valve functioning, if clogged, replace it.
Clogged filter.	Replace the filter.
Clogged pump.	Replace the pump.
Clogged membranes.	Replace the membranes.



It is recommended to install a manometer on the pump outlet to check operating pressure.

<b>Problem:</b>	Treated water has a bad taste.
<b>Cause</b>	<b>Solution</b>
Exhausted filters.	Replace the filters.
Biofouling.	Make machine disinfection.

<b>Problem:</b>	With the faucet closed, the machine restarts for a few seconds.
<b>Cause</b>	<b>Solution</b>
Check valve damaged.	Replace the check valve installed on the permeate line before max. pressure switch (install a manometer on permeate line and check water pressure on permeate line).
Water leakage.	Check the permeate hydraulic circuit for leakages (install a manometer on permeate line and check water pressure on permeate line).

<b>Problem:</b>	With faucet opened, the machine doesn't start.
<b>Cause</b>	<b>Solution</b>
Defective pressure switch.	Check pressure switch functioning, if damaged replace it.
Electric connection failure.	Check electric connections and tight if necessary.

<b>Problem:</b>	With faucet closed, the machine never stops.
<b>Cause</b>	<b>Solution</b>
Defective pressure switch.	Check pressure switch functioning, if damaged replace it.
Damaged board.	Replace the board.

<b>Problem:</b>	With faucet opened, the machine operates in a discontinuous mode.
<b>Cause</b>	<b>Solution</b>
Max pressure switch calibration is too low.	Perform the calibration of pressure switch.

<b>Problem:</b>	Service pressure is too low.
<b>Cause</b>	<b>Solution</b>
Preload too low.	Run the preloading of the pressure tank.
Max pressure switch calibration is too low.	Perform the calibration of pressure switch.

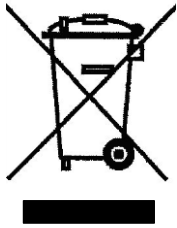

WASTE OF ELECTRICAL / ELECTRONIC EQUIPMENT  
RACCOLTA RIFIUTI DI MATERIALE ELETTRICO / ELETTRONICO  
RECOLHA DE RESÍDUOS DE MATERIAIS ELÉCTRICO / ELECTRÓNICOS  
ABFALLENTSORGUNG ELEKTRISCHES / ELEKTRONISCHES MATERIAL  
RECOGIDA DE RESIDUOS ELECTRICOS / ELECTRONICOS  
COLLECTE DES DÉCHETS DE MATÉRIEL ELECTRIQUE / ELECTRONIQUE  
VERZAMELING AFVAL ELEKTRISCH / ELEKTRONISCH MATERIAAL

(UK) EU directive 2002/96/EC classifies this product as an electrical or electronic tool.

**Do Not dispose of this tool as unsorted municipal waste.**

Dispose of this tool at a collection or recycling centre according to local and national law.

The consumer has an important role in reducing the disposal of waste by returning waste electronic/electrical tool for recycling. Recycling avoids the dispersion of hazardous materials into the municipal waste stream.

The crossed-out bin symbol reminds the user not to dispose of this product as unsorted municipal waste.

(I) Ai sensi dell'art. 13 del Decreto Legislativo 25 luglio 2005, n°151 "Attuazione delle Direttive 2002/95/CE, 2002/96/CE e 2003/108/CE, relative alla riduzione dell'uso di sostanze pericolose nelle apparecchiature elettriche ed elettroniche, nonché allo smaltimento dei rifiuti.

Il simbolo del cassonetto barrato riportato sull'apparecchiatura o sulla confezione indica che il prodotto alla fine della propria vita utile deve essere raccolto separatamente dagli altri rifiuti.

L'utente dovrà, pertanto, conferire l'apparecchiatura giunta a fine vita agli idonei centri di raccolta differenziata dei rifiuti elettronici ed elettrotecnici, oppure riconsegnarla al rivenditore al momento dell'acquisto di una nuova apparecchiatura di tipo equivalente, in ragione di uno a uno.

L'adeguata raccolta differenziata per l'avvio successivo dell'apparecchiatura dismessa al riciclaggio, al trattamento e allo smaltimento ambientale compatibile contribuisce ad evitare possibili effetti negativi sull'ambiente e sulla salute e favorisce il reimpiego e/o riciclo dei materiali di cui è composta l'apparecchiatura.

Lo smaltimento abusivo del prodotto da parte dell'utente comporta l'applicazione delle sanzioni amministrative previste dalla normativa vigente.

(P) A directiva 2002/96/EC classifica este producto como um instrumento eléctrico/electrónico.

**Não deitar este instrumento com lixo municipal não classificado.**

Deitar este aparelho em um centro de recolha ou de reciclagem segundo a lei local e nacional.

O consumidor tem uma importante responsabilidade na redução do lixo, preparando a reciclagem dos instrumentos eléctrico/electrónicos. A reciclagem previne a dispersão de materiais perigosos nos lixos municipais.

O símbolo da barra no barril lembra ao utilizador de não jogar este producto como um lixo municipal não classificado.

(D) Gemäß Richtlinie 2002/96/EC wird diese Produkt als elektrisches/elektronisches Gerät eingestuft.

**Dieses Gerät nicht als nicht klassifizierten Stadtmüll beseitigen.**

Diese Gerät an eine dafür vorgesehene Sammelstelle bringen, gemäß den vorortigen und auf nationalem Gebiet geltenden Gesetzesbestimmungen.

Der Verbraucher kann beträchtlich dazu beitragen den Abfall zu verringern, indem er ein Recycling der elektrischen/elektronischen Geräte vorsieht.

Ein Recycling verhindert, dass gefährliches Material im allgemeinen Stadtmüll beseitigt wird.

Das Symbol mit ausgestrichener Tonne soll bedeuten, dass das damit gekennzeichnete Produkt nicht als nicht klassifizierter Stadtmüll zu beseitigen ist.

(ES) La directiva 2002/96/EC clasifica este producto como un aparato eléctrico/electrónico.

**No tire este aparato como si fuera un residuo municipal no clasificado.**

Tire este aparato en un centro de recogida o de reciclaje según la ley local o nacional.

El consumidor cumple un papel importante en la reducción de la eliminación de residuos, predisponiendo el reciclaje de los aparatos eléctricos/electrónicos. El reciclaje previene la dispersión de materiales peligrosos en la gran cantidad de residuos municipales. El símbolo del bidón con una banda transversal recuerda al usuario que no debe tirar este producto como si fuera un residuo municipal no clasificado.

(F) La directive 2002/96/EC classifie ce produit comme appareil électrique/électronique.

**Ne pas jeter cet appareil avec les déchets municipaux non classifiés.**

Jeter cet appareil dans un centre de collecte ou de recyclage conformément à la loi locale et nationale.

Le consommateur joue un rôle important dans la réduction des déchets, en prévoyant le recyclage des appareils électriques/électroniques. Le recyclage permet d'éviter la dispersion de matériau dangereux dans la masse des déchets municipaux. Le symbole du bidon barré rappelle à l'utilisateur de ne pas jeter ce produit avec les déchets municipaux non classifiés.

(NL) De richtlijn 2002 / 96 / EC classificeert dit product als een elektrisch / elektronisch gereedschap.

**Gooi dit gereedschap niet weg als een niet geclassificeerd gemeentelijk afval.**

Breng dit gereedschap in een verzamel- of verwerkingscentrum volgens de plaatselijke en nationale wet.

De verbruiker speelt een belangrijke rol in het verminderen van het afval door de verwerking van de elektrische / elektronische gereedschappen voor te bereiden.

De verwerking voorkomt de verspreiding van gevaarlijk materiaal in de massa van het gemeentelijk afval.

Het symbool van de versperde vuilnisbak herinnert aan de verbruiker dit product niet weg te gooien als een niet geclassificeerd gemeentelijk afval.

ATTACHMENT I - CE declaration

CE DECLARATION OF COMPLIANCE 

**THE MANUFACTURER**

DECLARES THAT THE PRODUCT

**7280.0145**

REVERSE OSMOSIS EQUIPMENT

HAS BEEN DESIGNED AND BUILT IN COMPLIANCE WITH THE FOLLOWING DIRECTIVES:

MACHINES	2006 / 42 / CE
LOW TENSION	2006 / 95 / CE
ELECTROMAGNETIC COMPATIBILITY	2004 / 108 / CE

FURTHERMORE IT RESPECTS THE TECHNICAL PROVISIONS CONCERNING  
EQUIPMENT FOR THE HOUSEHOLD USE OF DRINKABLE WATER INDICATED IN THE:

**EN60335-1:2004** Safety of electrical domestic device or similar.

Castelfranco Veneto 01/2010

## ATTACHMENT II - SPARE PARTS AND ACCESSORIES LIST 7280.0145

Spare parts for routine maintenance			
Code	Code	Code	Code
1198002	Motor joint	5200179	Fuse 5x20 3.15A
1500106	Pump 500 LT/H brass BY-PASS STD 3/8" ring connection	Y21402B	CARTUCCIA PROFINE MEDIUM ARGENTO CEN
1100127	Membrane 3012 300gpd	1100232	OR 1.78 X 11.11 (114) EPDMPA
1100128	Vessel 3012 ATT. 1/4" PERM. 3/8"		

Spare parts for extraordinary maintenance			
Code	Code	Code	Code
1196001	Vibration proof support M/F 15x15 M4x6	7098014	Adhesive electronic board
9598001	Motor 250W - 220V	5296043	Solenoid valve 3/4" 10mm 2 pass 230V IP55
1100123	K5 new conductivity probe	1100129	Clip for vessel 3012
2596031	Wiring PRS	1100126	O-RING 2-201 201 3,53X4,34 EPDMPA
1500256	Pressure switch GP110 1/4"	1100166	O-RING 3056 2.62X13.95 SILIC.
5098001	7280.0145 electronic board	1500263	Pressure swithc 2 VIE GP200A
Y21301B	Tested in series Profine TW	1500265	Expansion tank AC GPM 25 CE ATT. 3/4"

Pipe fittings and components for installation			
Code	Code	Code	Code
9300114	T 3/8" PVC threaded	9300141	Check valve 10mm
9300174	Intermediate elbow 10mm	9300405	T intermediate 10mm
9300260	Male connector 10 x 3/8" BSP-P	9300126	8mm wall guide
9300469	Famale adapter 6 x 1/4" BSP-P	9300128	10mm wall guide
9300360	Threaded elbow 10 x 1/2" BSP-P	9300305	Plug 10mm
9300392	T intermediate 12-10mm	9300310	Riduction 4 - 6 MM
9300404	T reduced intermediate 10 - 6 mm	9300389	Stem elbow 10 - 6mm
9300359	Stem adapter 10 x3/8" bspp	9300236	Male connector 10 x 1/4" bspt
9300129	Stem adapter 12 x 1/2"	9300106	Pipe 3/4" FF
9400300	Check valve MF 3/8"	9300149	Flow regulator 6mm

## ATTACHMENT II - CE Label

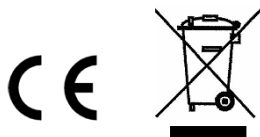

ANNO YEAR	<b>gen-10</b>	VOLT	<b>230V</b>
MODELLO MODELL	<b>RO-80</b>	Hz	<b>50Hz</b>
TIPO TYPE	<b>STANDARD</b>	WATT	<b>250W</b>
N. SERIE SERIAL NO.		<b>MADE IN ITALY</b>	





# ATTACHMENT V - Electronic board connection

